



## Coil Spring Conversion Kit

TF262 - Land Rover Discovery 4 - Standard Height 04658A-AA-01

### INTRODUCTION



Thank you for your purchase of a coil spring conversion kit from *Dunlop Suspension Systems*, suitable for the Land Rover Discovery series 4 vehicle (Model years 2009 – 2016). Please follow the instructions in this manual carefully in order to ensure correct and safe installation.

### \*\*\* SAFETY PRECAUTIONS \*\*\*



**NEVER** work beneath a vehicle supported only by a jack. **ALWAYS** use axle stands.

Wear eye protection and gloves throughout the installation process. A full-face visor is recommended if available.

### \*\*\* VERY IMPORTANT \*\*\*

Any faults with the original air suspension system should be diagnosed prior to fitting the coil spring conversion kit. The air suspension ride height sensors are used by various vehicle systems, and **must** be left installed on the vehicle and confirmed to be functioning properly before fitting the coil spring kit.

### YOUR KIT

Your kit comprises of the following items...



**Front Strut**

Part No. 04655A-AA

Quantity: 2



**Rear Strut**

Part No. 04656A-AA

Quantity: 2



**Disarm Kit and Instructions**

Part No. 04657A-AA

Quantity: 1

## FITTING INSTRUCTIONS

Installation of the coil spring kit is a three-stage process...

1. Removal of Standard Air Struts
2. Fitting of Coil Spring Struts
3. Preparation of the vehicle for use with coil struts via a 'Disarm Module'

The following tools are required...

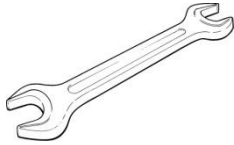

15mm Spanner	Top Mounting Nuts, All Struts
12mm Spanner	Air Supply Fitting Nut
21mm Spanner	Bottom Bolt Head, All Struts
24mm Socket	Bottom Bolt Nut, All Struts
18mm Socket	Toe Link Bolt Head
Torque Wrench	Tighten to specified torque

Each installation stage is detailed in the following subsections. *Except where indicated otherwise, follow the same procedure for both the front struts and the rear struts.*

### STAGE 1: REMOVAL OF STANDARD AIR STRUTS

1. **Depressurisation:** If an official *Land Rover* air suspension diagnostic system is available, use it to depressurise the air suspension system. If the diagnostic system is not available, invoke vehicle 'Access Mode' (i.e. lower the vehicle) via the 'Air Suspension Switch' located on the centre console (see below): Switch-on the ignition (there is no need to start the engine) and press the left-side switch downwards. This action will release most of the compressed air from within the system.



2. Raise the vehicle and support it appropriately
3. Remove the road wheel at the 'corner' from which the first strut is to be removed
4. **Rear of Vehicle Only:** A 'Toe Link Arm' extends across the strut near the bottom end at both the left- and right-side of the vehicle at the rear. This presents an obstruction to removal of the strut and therefore it is necessary to move it clear temporarily. Unscrew and remove the bolt **A**, and push the rod away from the base of the strut.



5. Free the strut from its fastenings...

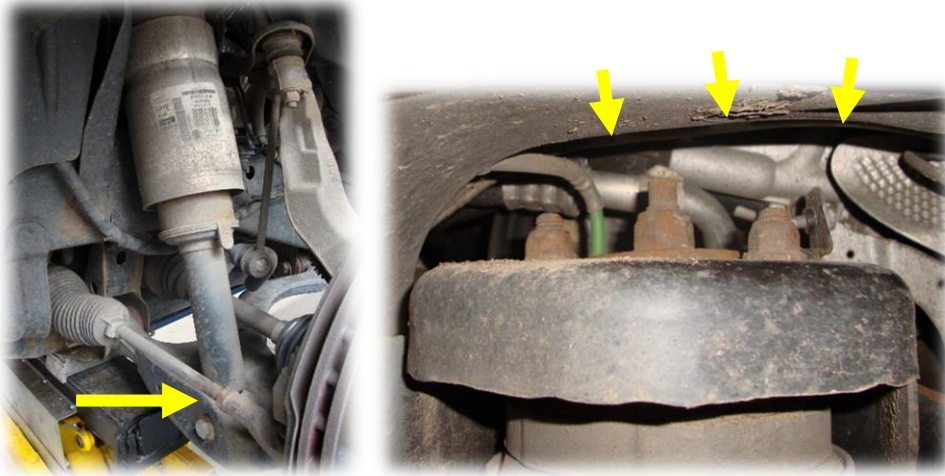

Disconnect the strut at the lower end from the vehicle suspension arm by unscrewing and removing the long bolt (above, left). At the upper end, remove the three nuts that attach the top of the strut to the bracket on the chassis (above, right). This will free the strut and so take care to support the weight until the air line is disconnected.

6. Fully disconnect the air fitting from the strut: *Was the air suspension system depressurised via the official Land Rover air suspension diagnostic system in step 1?*...

- ... **YES** - unscrew the nut that secures the air tube to the strut and pull clear
- ... **NO** - see 'Manual Depressurisation' below



*Optional...*

If the air tubes are to be left in place on the vehicle, close-off their exposed ends in order to prevent ingress of water and/or contaminants.

The photograph shows a cap placed over an exposed tube end.

### Manual Depressurisation



#### **CAUTION! \* Potential for Violent Decompression \***

The air suspension system contains compressed air...

- ... Wear gloves and eye protection
- ... Use a full-face visor if available

**SLOWLY AND CAREFULLY** loosen the nut that secures the air tube to the strut. As an additional precaution, do this with your face as far as possible from the site of the nut. Stop loosening the nut as soon as air is heard to escape and wait until all of the air has been released from the strut before proceeding further.

7. Repeat steps 5 and 6 at the remaining three 'corners' of the vehicle



## STAGE 2: FITTING OF COIL SPRING STRUTS

1. Hold the strut at the fitting site and find the correct orientation, in which...
  - a. the three threaded pins in the top plate align with the holes through which they are to pass and
  - b. the shock absorber 'eye' housing aligns with the slot on the lower suspension arm vacated by removal of the air strut



2. Manoeuvre the strut upwards until the three pins in the top plate pass through the corresponding holes in the chassis housing, at the same time ensuring that the shock absorber eye housing lines-up with its fastening location in the lower arm. Secure the strut loosely at the top via 3-off M10 x 1.5mm nuts.
3. Manoeuvre the damper 'eye' housing into position against the lower arm bracket, align the holes, slide the bolt through, affix the nut and tighten to torque 300Nm (221lbf.ft)



4. Tighten the three nuts at the top of the strut to torque  $63\text{Nm} \pm 10\%$  (46.5lbf.ft  $\pm 10\%$ ) in order to secure it to the chassis housing
  5. **(Rear of Vehicle Only)** Reattach the Toe Link Arm via bolt **A**. Tighten to torque 175Nm (129lbf.ft).
6. Refit the road wheel and tighten the wheel nuts to torque 140Nm (103lbf.ft)

### STAGE 3: 'DISARM MODULE'



*'Disarm Module'*

With the coil spring struts in place, the final stage is to suspend the activity of the air suspension system control unit using the 'Disarm Module' (illustrated above) and electrical harness provided. This module must be permanently connected into the vehicle harness, as described in this section.

The photograph below shows the electrical harness and module, and indicates the connections to be made...

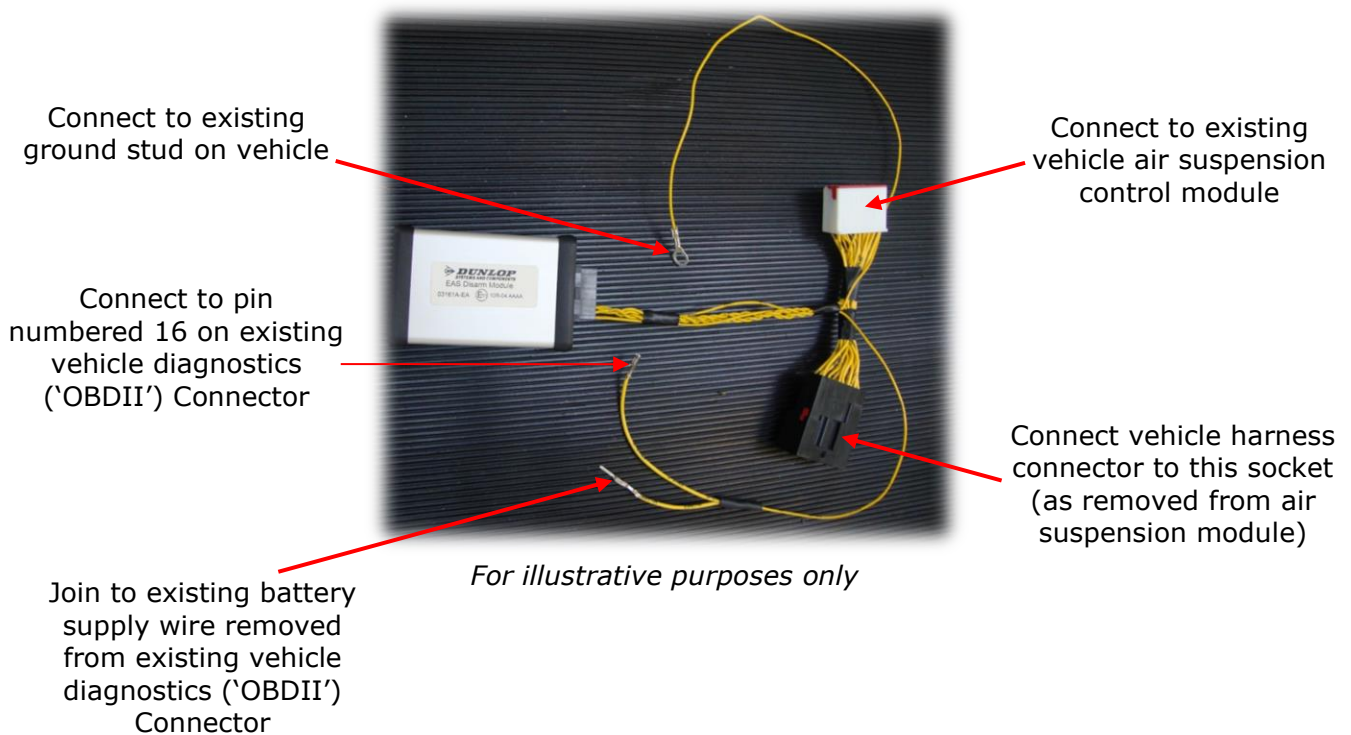

## Procedure

**Note that the following procedure refers to right hand drive vehicles – the procedure is mirrored for left hand drive models.**

1. **!! VERY IMPORTANT!!** Disconnect the vehicle battery...



Note: It is sufficient to disconnect the positive terminal only (red wiring)

2. Remove panelling from the footwell at the right hand side of the vehicle, as shown below. This will provide for access to the air suspension system control unit.



*Vehicle Footwell, Right-hand Side,  
Panelling in Place*



*Vehicle Footwell, Right-hand Side,  
Panelling Removed*

3. The control unit is positioned against the inside wall of the vehicle, as indicated in the photograph below. Unplug the white connector from the underside of the unit, as shown on this photograph and overleaf.

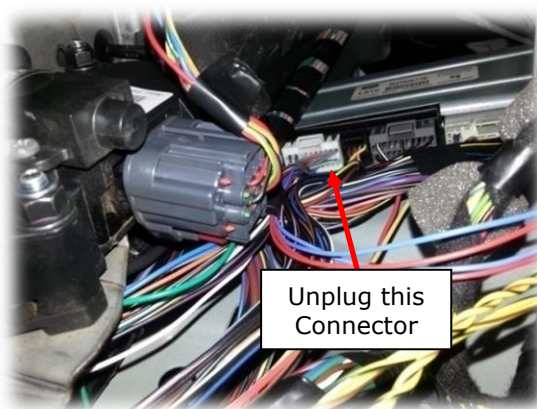

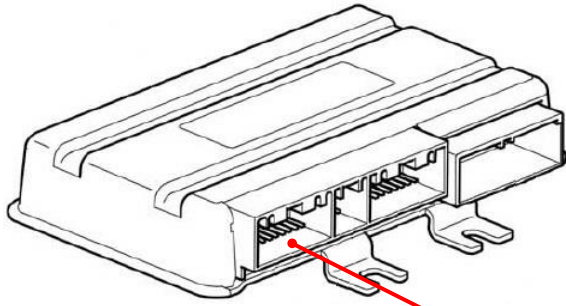

Remove 20-pin white connector from position indicated

4. Plug the white connector of the coil spring kit harness into the air suspension control module socket vacated in the previous step
5. Locate the white connector of the vehicle harness unplugged in step 3 and plug this into the black socket of the coil spring kit harness
6. Connect the coil spring kit harness wire with a ring termination to an existing vehicle ground stud, for example as shown here...

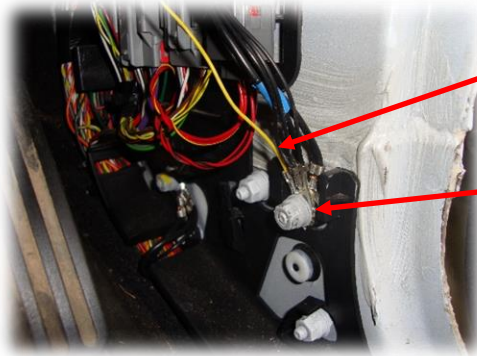

Coil Kit Harness Wire (yellow) with Ring Terminal

Existing Vehicle Ground Stud

7. Unclip and temporarily remove the existing vehicle diagnostics ('OBDII') connector...

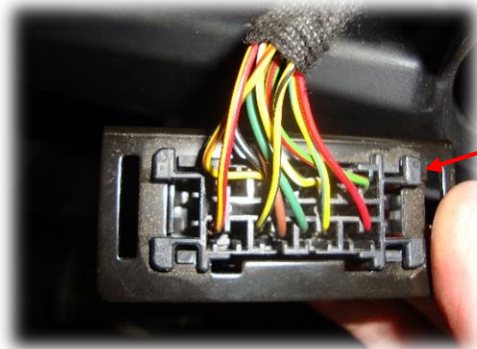

Existing vehicle diagnostics ('OBDII') connector, shown temporarily disconnected from seat

8. Locate pin #16 of the diagnostics connector (observe numbering on the connector). Using a fine screwdriver or similar fine-ended implement, lift the tab associated with this pin and pull out the (red/yellow-coloured) wire from it.

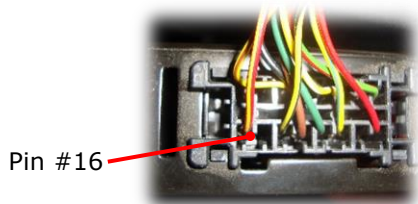

Pin #16

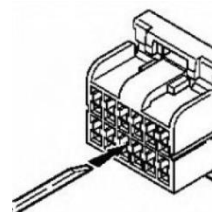

Pin #16 is located bottom-left when the connector is viewed as shown

To remove a wire from the connector, lift the tab associated with it as indicated here



9. Locate the wire of the coil spring kit harness that terminates with a small socket. Attach this socket to the pin (#16) of the vehicle diagnostics connector vacated in the previous step.
10. Slide heat shrink over the remaining loose wire of the coil spring kit harness, which terminates with a pin. Attach this wire to the existing (red/yellow-coloured) wire of the vehicle harness which was pulled-out of the diagnostics connector in step 8. Slide the heat shrink to cover the exposed metal parts of the new connection and apply heat to establish it in position...

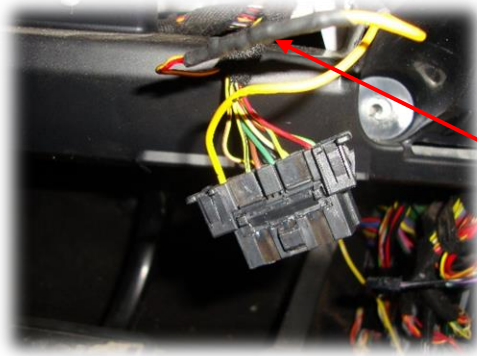

Vehicle harness wire (red/yellow, left) connected to remaining loose wire of disarm module harness (yellow, right) and heat shrink applied

11. Re-fit the vehicle diagnostics ('OBDII') connector
12. Using the cable zip ties provided, secure the coil spring kit module in a suitable place close to the vehicle air suspension module.
13. Re-fit all of the panelling removed in step 2
14. Reconnect the vehicle battery
15. Switch-on the vehicle ignition – **Do not start the engine.** Confirm that there are no suspension error messages / warning symbols displayed on the instrument panel (see the vehicle owners' manual for a listing of messages and symbols with definitions). Wait for a minimum of 10 seconds.



The vehicle is now ready to be operated with coil spring suspension

**\*\* IMPORTANT NOTE \*\***

After fitting the coil spring disarm module, the following diagnostic trouble code (DTC) will be present and would be indicated by a diagnostics scan tool...

Air Suspension Control Module (RLM) -- U3000-52

This DTC **is not** a fault condition - it is set to indicate that the air suspension system has been deactivated.