





If required, vehicle should be jacked up evenly and safely supported with stands. Compare new supplied components to old parts for correct application and contents.

Be careful when working near hot components, such as exhaust systems. We recommend removing/servicing only 1 arm at time.

Careful to not damage Eye-rings when pressing out old bushings. Ensure all components are free from rust, scale and dirt.

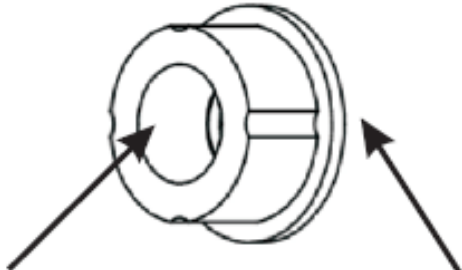
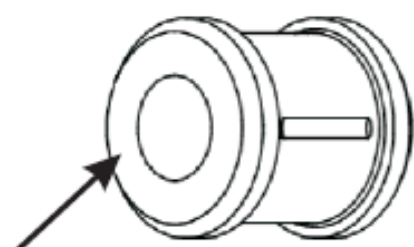
It is recommended all components be tightened when vehicle is at ride-height. Carry out a wheel alignment after install - re-check bolts after 100kms travelled.

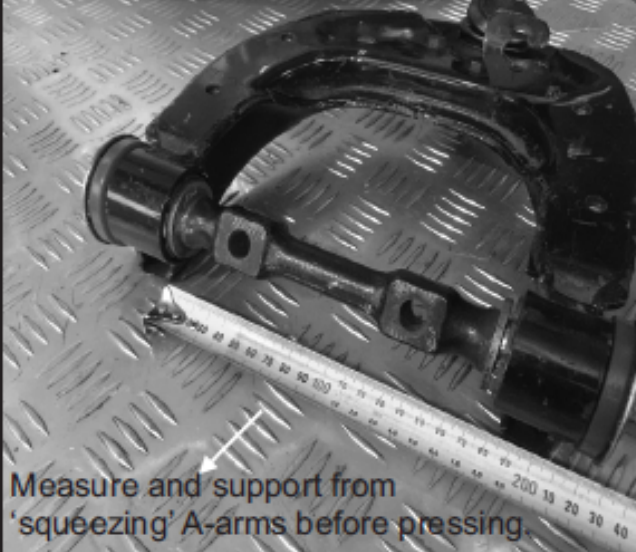
<p>2-piece bushings can be pushed in easily.</p>  <p>Grease bushing internal diameter and face with supplied grease only.</p>	<p>1-piece bushings will need to be pressed in.</p>  <p>This is best achieved with soapy water and 2 flat surfaces</p>
<p>Measure and Prevent squeezing Eye rings</p> 	<p>Measure and support from 'squeezing' A-arms before pressing.</p> 

WARRANTY & DISCLAIMER - Terrafirma products are warranted free from defects in materials and workmanship for a period of 12 months from the date of retail invoice. Terrafirma does not warrant that the products manufactured or marketed by it comply with the laws of the country where those goods are purchased or used. It is the sole responsibility of the purchaser to ascertain whether products being purchased, or the fitting of those products to any other object, comply with local laws. This warranty covers structural defect and workmanship but does not cover finishes, labour charges for removal or refitting, freight costs, accident damage, misuse or abuse, damage due to incorrect or improper fitment or application, modified product, faulty design or consequential damage of any kind. Damage or defects caused by collision, alteration, improper installation, road hazards, adverse conditions or usage for any other purpose other than normal private usage are not covered by this warranty. Terrafirma shall not be liable for any other claim relating to the use of the product and any indirect special or consequential damage or injury to any person, company or other entity. All claims must be accompanied by the original retail invoice and should be submitted to the supplying Allmakes 4x4/Terrafirma distributor. This warranty covers only the replacement of the product or part concerned. The decision remains solely at the discretion of Allmakes Ltd. The information contained in this catalogue was correct at the time of going to press. Allmakes/Terrafirma and its associated companies reserve the right to alter the range and any product specifications without notice. Always consult your Allmakes/Terrafirma distributor for the latest product information and specifications. The Terrafirma range of products is constantly being evaluated for enhancement and improvement to make sure the level of quality and performance is as expected.

TF1012



General instructions - swaybar bushings, drop links & control arms

Please read instructions carefully. Improper installation may result in premature failure.

If required, vehicle should be jacked up evenly and safely supported.

Ensure all components are free from rust, scale and dirt.

Compare new supplied components to old parts for correct application.

Be careful when working near hot components, such as exhaust systems.

Swaybars vertical links do not require greasing. Swaybar mounting points (D bushings) do require greasing - grease ID of bushing only.

Drop links, control arms and track bars with a pivoting bushing do require greasing - bushing ID and side face must be greased with the supplied grease only.

It is recommended all components be tightened when vehicle is at ride-height.

Depending on application and suspension component removal, it may be necessary to carry out a Wheel Alignment post install.

We suggest re-checking all hardware after initial 100kms travelled.

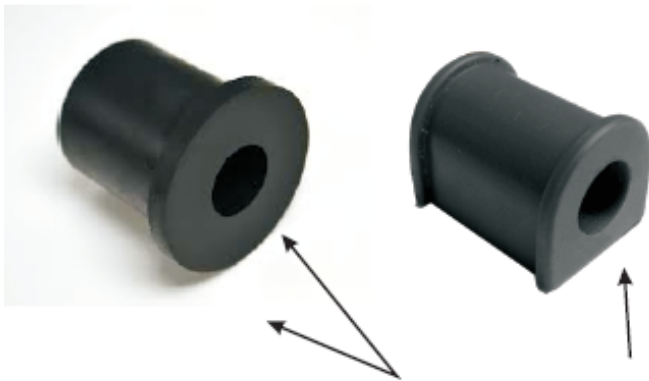

Grease bushing face and ID only

Grease bushing ID only

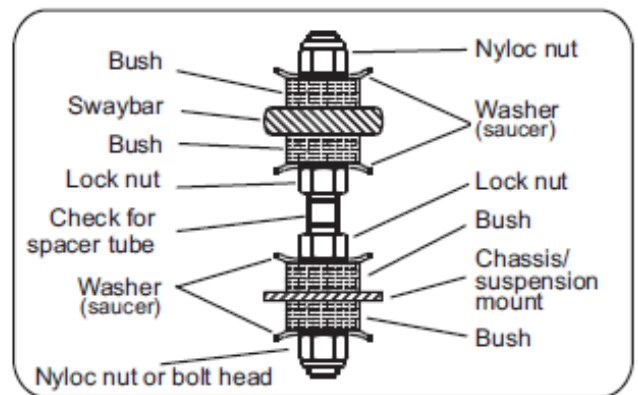

Caution: Do not over tighten swaybar pin type link bushings.

Over tightening will reduce articulation and may cause premature failure.

Place cupped washers so they taper away from bushings - this will aid articulation.

N.B: It is recommended that a licenced workshop or tradesperson carry out the above procedure and that workshop manual and relevant safety procedures are followed in addition to the above.

WARRANTY & DISCLAIMER - Terrafirma products are warranted free from defects in materials and workmanship for a period of 12 months from the date of retail invoice. Terrafirma does not warrant that the products manufactured or marketed by it comply with the laws of the country where those goods are purchased or used. It is the sole responsibility of the purchaser to ascertain whether products being purchased, or the fitting of those products to any other object, comply with local laws. This warranty covers structural defect and workmanship but does not cover finishes, labour charges for removal or refitting, freight costs, accident damage, misuse or abuse, damage due to incorrect or improper fitment or application, modified product, faulty design or consequential damage of any kind. Damage or defects caused by collision, alteration, improper installation, road hazards, adverse conditions or usage for any other purpose other than normal private usage are not covered by this warranty. Terrafirma shall not be liable for any other claim relating to the use of the product and any indirect special or consequential damage or injury to any person, company or other entity. All claims must be accompanied by the original retail invoice and should be submitted to the supplying Allmakes 4x4/Terrafirma distributor. This warranty covers only the replacement of the product or part concerned. The decision remains solely at the discretion of Allmakes Ltd. The information contained in this catalogue was correct at the time of going to press. Allmakes/Terrafirma and its associated companies reserve the right to alter the range and any product specifications without notice. Always consult your Allmakes/Terrafirma distributor for the latest product information and specifications. The Terrafirma range of products is constantly being evaluated for enhancement and improvement to make sure the level of quality and performance is as expected.

TF1012



WARRANTY & DISCLAIMER - TerrafirMa products are warranted free from defects in materials and workmanship for a period of 12 months from the date of retail invoice. TerrafirMa does not warrant that the products manufactured or marketed by it comply with the laws of the country where those goods are purchased or used. It is the sole responsibility of the purchaser to ascertain whether products being purchased, or the fitting of those products to any other object, comply with local laws. This warranty covers structural defect and workmanship but does not cover finishes, labour charges for removal or refitting, freight costs, accident damage, misuse or abuse, damage due to incorrect or improper fitting or application, modified product, faulty design or consequential damage of any kind. Damage or defects caused by collision, alteration, improper installation, road hazards, adverse conditions or usage for any other purpose other than normal private usage are not covered by this warranty. TerrafirMa shall not be liable for any other claim relating to the use of the product and any indirect special or consequential damage or injury to any person, company or other entity. All claims must be accompanied by the original retail invoice and should be submitted to the supplying Allmakes 4x4/TerrafirMa distributor. This warranty covers only the replacement of the product or part concerned. The decision remains solely at the discretion of Allmakes Ltd. The information contained in this catalogue was correct at the time of going to press. Allmakes/TerrafirMa and its associated companies reserve the right to alter the range and any product specifications without notice. Always consult your Allmakes/TerrafirMa distributor for the latest product information and specifications. The TerrafirMa range of products is constantly being evaluated for enhancement and improvement to make sure the level of quality and performance is as expected.